

VISION AIRCRAFT PARTS CATALOG 2011

*Let's get moving! Save some time and get'er done!
Precision Parts are now available for the Vision and many more
coming in 2012*

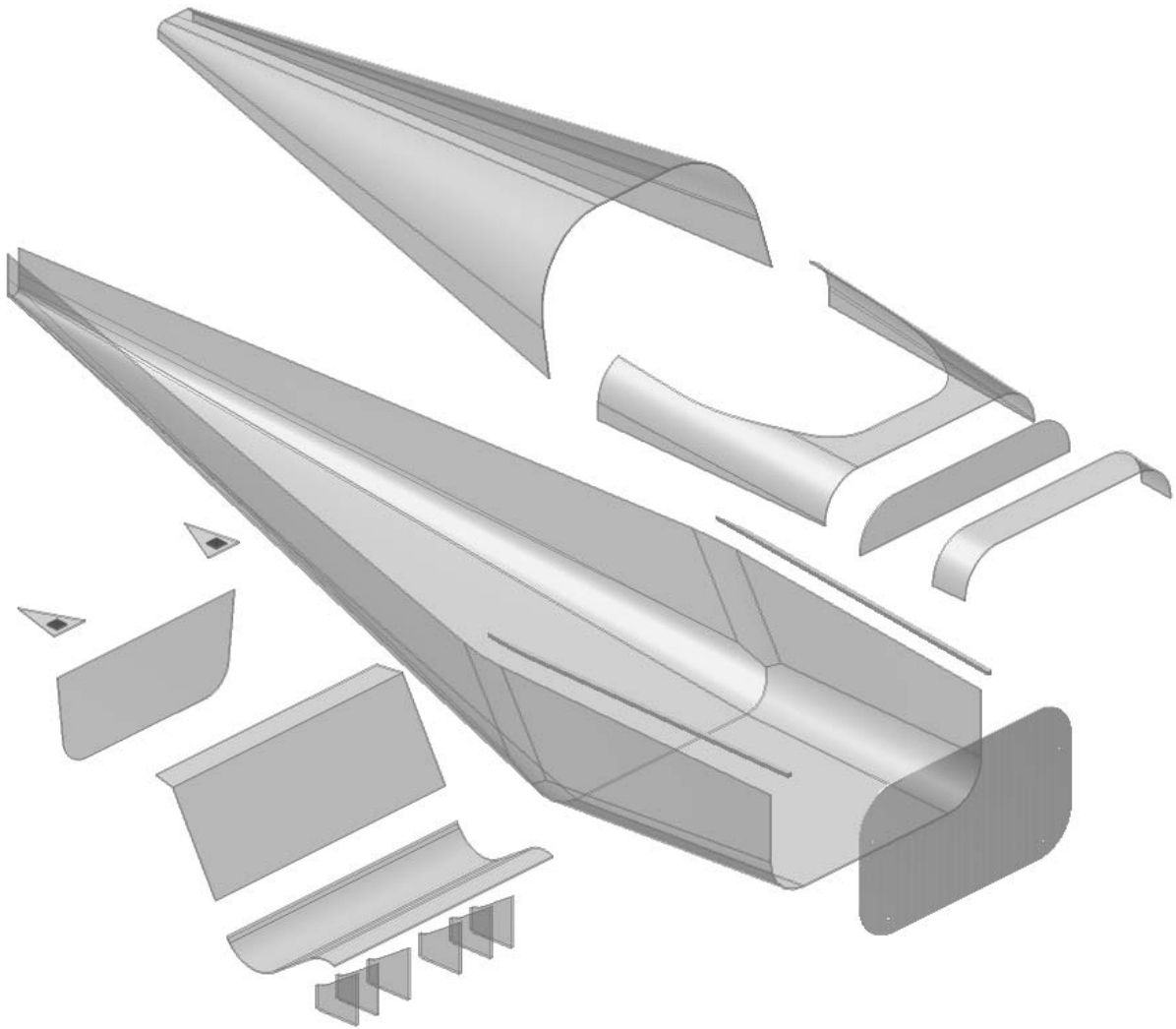



New Fast Build Kit coming in 2012

VISION AIRCRAFT PARTS CATALOG 2011

High Quality Economical parts that save you time and money. Proudly made in the USA.

	<p>Elevator Aft Idler plate</p> <p>Laser cut 4130. Ready to accept BC4W10 bellcrank bearing. 2 required</p> <p style="text-align: right;">Part No. 90001</p>	<p>Price Each</p> <p style="text-align: center;">\$8</p>
---	--	--

	<p>Elevator Forward Idler plate</p> <p>Laser cut 4130. Ready to accept BC4W10 bellcrank bearing. Price each. 2 required.</p> <p style="text-align: right;">Part No. 90002</p>	<p>Price Each</p> <p style="text-align: center;">\$8</p>
---	---	--

	<p>Aileron Idler plate</p> <p>Laser cut 4130. Ready to accept BC4W10 bellcrank bearing. Price each. 2 required.</p> <p style="text-align: right;">Part No. 90003</p>	<p>Price Each</p> <p style="text-align: center;">\$8</p>
--	--	--

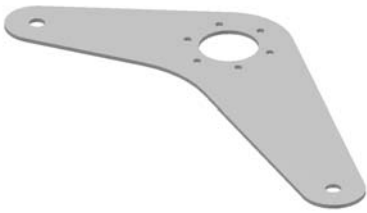
	<p>Aileron bellcrank</p> <p>Laser cut 4130. Bearing with stiffener (not shown). Price each. 2 required. Stiffener must be welded to bellcrank.</p> <p style="text-align: right;">Part No. 90004</p>	<p>Price Each</p> <p style="text-align: center;">\$10</p>
---	---	---

	<p>Aileron pushrod plate</p> <p>Laser cut. 4 required.</p> <p style="text-align: right;">Part No. 90005</p>	<p>Price Each</p> <p style="text-align: center;">\$8</p>
---	---	--

VISION AIRCRAFT PARTS CATALOG 2011

High Quality Economical parts that save you time and money. Proudly made in the USA.

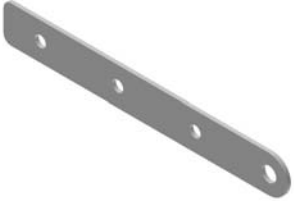
	<p>Flap pushrod plate</p> <p>Laser cut. Price each. 4 required.</p> <p>Part No. 90006</p>	<p>Price Each</p> <p>\$8</p>
---	---	--

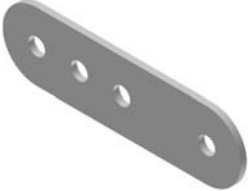
	<p>Rudder Pedal Cable attachment plate</p> <p>Laser Cut. Price each. 2 Required.</p> <p>All holes drilled to .25"</p> <p>Part No. 90007</p>	<p>Price Each</p> <p>\$6</p>
---	---	--

	<p>Spar Bushing Kit</p> <p>These custom close tolerance bushings are required for installation of the main spar. Made from AL 6061-T6. Kit includes - 4 flange bushings and 2 large sleeve bushings.</p> <p>Part No. 90009</p>	<p>Price Each</p> <p>\$92.50</p>
--	--	--

	<p>1.25" Rod End boss</p> <p>For 1.25" x .058 wall aluminum tubing push rods. Ready to accept MM-4 Aurora Bearings. Price each. Qty of 8 required for Vision.</p> <p>Simplifies assembling pushrods and saves around \$60 as it does not require purchase of AN490HT8P's or additional machined bushings or drilling through the AN490, (a.k.a. drill bit breaker.) Bond in and cross bolt per plans.</p> <p>Part No. 90010</p>	<p>Price Each</p> <p>\$14.50</p>
---	---	--

VISION AIRCRAFT PARTS CATALOG 2011

High Quality Economical parts that save you time and money. Proudly made in the USA.

	<p>.75" Rod End boss</p> <p>For 0.75" x .058 wall aluminum tubing. Ready to accept MM-4 Aurora Bearings. Price each. Qty of 6 required for Vision. Rivets included.</p> <p>Simplifies assembling pushrods and saves \$\$\$ as it does not require purchase of AN490HT8P's or welding 4130 tubing. Just scuff, bond, drill and rivet. Replaces smaller steel pushrods from control stick to elevator idler and aileron idlers. Use with 6061-T6 .75 x .058 wall tubing.</p> <p style="text-align: right;">Part No. 900011</p>	<p>Price Each</p> <p>\$12.50</p>
---	--	--

	<p>Elevator weldment</p> <p>Precision Manufactured. Saves a lot time, meticulous alignment and welding.</p> <p style="text-align: right;">Part No. 900012</p>	<p>Price Each</p> <p>\$165</p>
--	---	--

	<p>Cowling</p> <p>Molded cowling will save a 100 hours. Ready to trim and fit to your Vision firewall. Spacious design to fit Lycoming O-320 and others.</p> <p style="text-align: right;">Part No. 90013</p>	<p>Price Each</p> <p>\$850</p>
---	---	--

VISION AIRCRAFT PARTS CATALOG 2011

High Quality Economical parts that save you time and money. Proudly made in the USA.

Order Form

Part No.	Description	Qty	Price	Total
90001	Elevator Aft Idler plate		\$8	
90002	Elevator Forward Idler plate		\$8	
90003	Aileron Idler plate		\$8	
90004	Aileron bellcrank		\$10	
90005	Aileron pushrod plate		\$8	
90006	Flap pushrod plate		\$8	
90007	Rudder Pedal Cable attachment plate		\$6	
90009	Spar Bushing Kit		\$92.50	
90010	1.25" Rod End boss		\$14.50	
90011	.75" Rod End boss		\$12.50	
90012	Elevator weldment		\$165	
90013	Cowling		\$850	
			Grand Total	

Order online and use your credit card or send in order form and mail a check to:

Pro-Composites, Inc.
113 McHenry Rd., PMB 369
Buffalo Grove, IL 60089

Email: orders@pro-composites.com for shipping quote or call 847-271-4795.